

PM-50

Red Lion Automation Series



▲ Digital Input Graphical Panel Meters

THE PM-50 METERS ARE DESIGNED TO INCREASE OPERATOR PRODUCTIVITY, EXPOSE CRITICAL PLANT FLOOR DATA, AND AID IN PROJECT SCHEDULING AND PROCESS IMPROVEMENTS. EASILY RELATABLE INTUITIVE GRAPHICAL DISPLAY. SECONDARY DISPLAYS PROVIDE EVEN MORE DATA. THE METERS FEATURE ON-BOARD Wi-Fi, RS-485/MODBUS, AND OPTIONAL ETHERNET OR RS-232.



GRAPHICAL DISPLAY

- ▲ Full color touchscreen
- ▲ Intuitive screens
- ▲ Multiple displays

SIMPLE PROGRAMMING

- ▲ Start-up Wizard
- ▲ Programming App
- ▲ Web server

ALARM NOTIFICATION

- ▲ Display color change
- ▲ Push messaging
- ▲ Focuses attention

DATA ACCESS

- ▲ Wi-Fi
- ▲ Modbus/RS485
- ▲ Ethernet & RS232

MODULAR CONSTRUCTION

- ▲ Plug-in play modules
- ▲ Upgradeable firmware
- ▲ Outputs, power & comms

EASY FIELD REPLACEMENT

- ▲ Use existing wiring
- ▲ 4.3" - 1/8 DIN products
- ▲ 3.5" - 1/16 DIN products

SMART DEVICE CAPABILITIES

- ▲ Functionality
- ▲ Programming
- ▲ Connectivity

PM-50 Ordering Guide and Specifications

Ordering Guide

MAIN UNIT

PART NUMBER	DESCRIPTION
PM500D0400800F00	4.3" Digital Input Graphical Panel Meter
PM500D0301600F00	3.5" Digital Input Graphical Panel Meter

ACCESSORIES

PART NUMBER	DESCRIPTION
PMM000CM23200000	RS232 Serial Communications Module
PMM000CMEN000000	Ethernet Communications Module
PMM000IOAN000000	Analog Output Module
PMM000IORL200000	Dual Setpoint Relay Output Module
PMM000IORL400000	Quad Setpoint Relay Output Module
PMM000PWACP00000	AC to DC Power Module
PMA000MK00800000	Conversion Panel 92 mm x 75 mm to 1/8 DIN
PMA000MK01600000	Conversion Panel 68 mm x 68 mm to 1/16 DIN
PMA000SP00800000	4.3" Protective Screen Overlay
PMA000SP01600000	3.5" Protective Screen Overlay
SD032G00	MicroSD Card
PMA000CP00800000	Replacement Rear Cover/Bus Board with Spacer Module (4.3" model only)
PMA000MKLP00000	Replacement Module Lock Pins

Meter Specifications

POWER REQUIREMENTS

MODEL	4.3-INCH	3.5-INCH
Input Voltage (Volts)	10-30 VDC	10-30 VDC
Max Power PM-50 only	4.6 W	4.6 W
Max Power PM-50, with modules	12 W	12 W

Host Isolation: 500 Vrms for 1 min. to all inputs and outputs.

DISPLAY

4.3" or 3.5" Color TFT display with resistive analog touch screen

SIZE	4.3-INCH	3.5-INCH
Type	TFT	TFT
Colors	262,144	262,144
Pixels	480 X 272	320 X 240
Brightness	420 cd/m ²	540 cd/m ²
LED Backlight Life*	30,000 HR TYP.	30,000 HR TYP.

* Lifetime at room temperature (25°C)

SENSOR POWER

+24 VDC, ±5% @ 50 mA max.

COUNTER DISPLAYS

9 digits available

Display Range: -99,999,999 to 999,999,999

Over Range Display: Overrange

Under Range Display: Underrange

Display Designators: Cnt-A, Cnt-B, Cnt-C

Maximum Count Rates: 50% duty cycle

If Setpoints Disabled: 35 KHz for all modes except Quadrature x4 (32 KHz)

If Setpoint(S) Enabled: 20 KHz for any mode except Quadrature x1 (19 KHz), Quadrature x2 (17 KHz) and Quadrature x4 (10 KHz)

RATE DISPLAYS

6-digit

Maximum Frequency: 50 KHz

Minimum Frequency: 0.001 Hz

Display Update Time: 0.1 to 999.9 seconds

Accuracy: ±0.01%

SIGNAL INPUTS (INPUT A AND INPUT B)

Software configurable input types including switch contacts, TTL outputs, magnetic pickups and all standard RLC sensors. Inputs are configurable for current sinking or current sourcing outputs with input filtering for low frequency signals or switch contact debounce. Not isolated from the sensor input common.

Logic: Input trigger levels $V_{IL} = 1.2 \text{ V max.}$; $V_{IH} = 3.75 \text{ V min.}$

Sink: Adds internal 7.8 K Ω pull-up resistor to +5 VDC, 0.7 mA max

Source: Adds internal 3.9 K Ω pull-down resistor, 7.3 mA max. at 28 VDC, $V_{MAX} = 30 \text{ VDC}$

Magnetic Pickup:

$V_{IN_PK} = 200 \text{ mV}$; $V_{IN_HSYS} = 100 \text{ mV}$; Must also have SRC selection turned on through software

$V_{MAX} = \pm 40 V_{PEAK}$ or 28 Vrms

Dual Count Modes:

When any dual count mode is used, then User Inputs 1 and/ or 2 will accept the second signal of each signal pair. The user inputs do not have the Logic/Mag, HI/LO Freq, and Sink/ Source software selections. The user inputs are inherently a logic input with no low frequency filtering implemented in software. The user input may only be selected for sink/source by the User Input Active parameter.

PM-50 Specifications Cont. and Module Specifications

USER INPUTS

Two programmable user inputs

MEMORY

Nonvolatile memory retains all programmable parameters and display values.
Memory Card: microSD slot accepts up to 32 GB capacity cards in FAT16/FAT32 format.

RS485 SERIAL PORT

Uses Modbus protocol (RTU and ASCII)
Baud Rate: Up to 115,200
Data Format: 7/8 bit; odd, even, or no parity; 1 or 2 stop bits
Isolation: 500 Vrms to sensor, user power and digital inputs. Not isolated to solid state outputs

Wi-Fi CAPABILITIES

Wi-Fi: Power output up to 20.5 dBm
Frequency:

TECHNOLOGY	CHANNELS	FREQUENCIES
Wi-Fi	1-13	2412-2484 MHz

Note: Channel/frequency limitation is enforced based on configured country/region code.

Wi-Fi Compliance: TCP/IP; 802.11 b/g/n

ON-BOARD DUAL SSR OUTPUTS

Both outputs must be used either in SINKING or in SOURCING mode together.

Sinking Mode:

Type: Switched DC, N-channel open drain MOSFET
Max Sink Current: 100 mA
 V_{DS} ON: 0.3 V @ 100 mA
 V_{DS} MAX: 30 VDC
Offstate Leakage Current: 0.5 mA max

Sourcing Mode:

Type: Switched DC, P-channel open source MOSFET
Max Source Current: 100 mA
 V_{DS} ON: 0.3 V @ 100 mA
 V_{DS} MAX: 30 VDC

Offstate Leakage Current: 0.5 mA max

ENVIRONMENTAL

Operating Temperature Range: -10 to 55 °C
Storage Temperature Range: -20 to 60 °C
Operating and Storage Humidity: 0 to 85% max. RH non-condensing
Vibration to IEC 68-2-6: Operational 5-500 Hz, 2 g
Shock to IEC 68-2-27: Operational 20 g (10 g relay)
Altitude: Up to 2000 meters
Installation Category II, Pollution Degree 2 as defined in IEC/EN 60664-1.

CERTIFICATIONS & COMPLIANCES

CE Approved
EN 61326-1 Immunity to Industrial Locations
Emission CISPR 11 Class A
IEC/EN 61010-1
RoHS Compliant
FCC ID#: 2AC7Z-ESP32WROOM32U
UL Hazardous: File # E317425
Type 4X Indoor/IP65 Enclosure rating (Face only) for all models
IP20 Enclosure rating (Rear of unit)

CONNECTIONS

High compression spring-clamp terminal block

CONSTRUCTION

This unit is rated NEMA 4X/IP65 for indoor use only. IP20 Touch safe. One piece bezel/case. Flame resistant. Panel gasket, module locks, and mounting panel latch included.

WEIGHT

4.3: 11.5 oz (326 g)
3.5: 8.1 oz (229.6 g)

WARRANTY

2 years on design and manufacturing defects.
Specifications are subject to change.
Visit www.redlion.net for more information.

Module Specifications

Note: All modules are field installable

RS232 MODULE

Removable terminal block
Hardware status LEDs

ETHERNET MODULE

10/100 Ethernet module
Auto MDI/MDI-X
Modbus over TCP/IP

ANALOG OUTPUT MODULE

Retransmitted analog output
0 (4) to 20 mA or 0 to 10 VDC, ± 10 VDC
Removable terminal block

DUAL RELAY MODULE

Dual Form C 5 Amp relays
Up to 250 VAC or 30 VDC
Removable terminal block

QUAD RELAY MODULE

Up to 250 VAC or 30 VDC
Removable terminal block
Quad Form A 2 Amp relays

AC TO DC POWER MODULE

Input: 85 VAC to 240 VAC
Supports 4.3" and 3.5" PM-50 meters
Removable terminal block

PM-50 Meter and Module Dimensions

Dimensions In inches (mm)

4.3 Inch Display

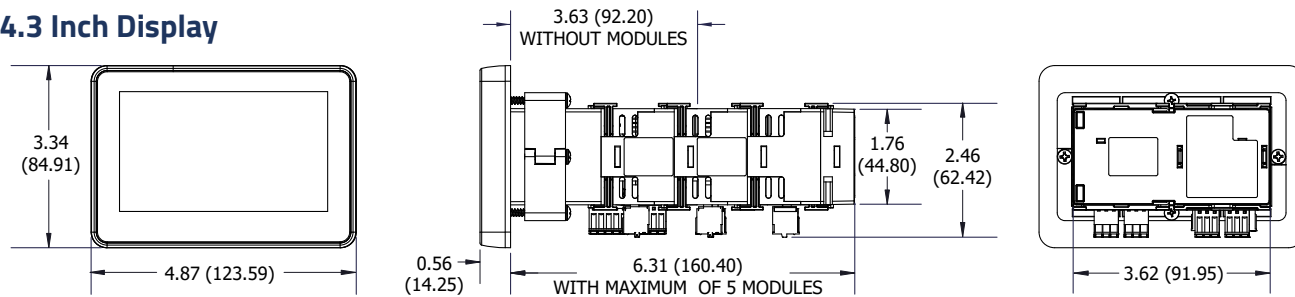

Dimensions In inches (mm)

3.5 Inch Display

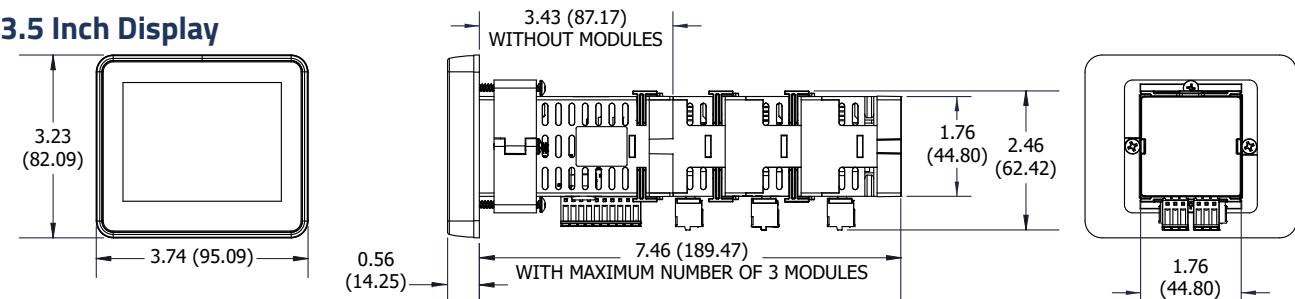

Dimensions In inches (mm)

Module

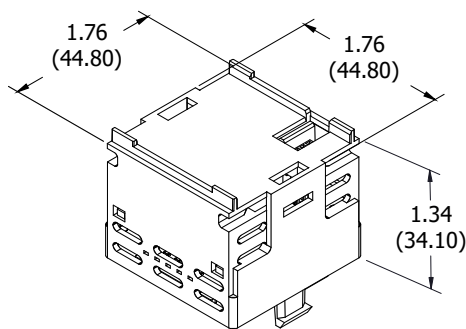

Red Lion has been delivering innovative solutions to global markets since 1972 through communication, monitoring and control for industrial automation and networking - enabling companies worldwide to gain real-time data visibility that drives productivity. Red Lion is part of Spectris plc, the productivity enhancing instrumentation and controls company.

www.redlion.net
[contact us](#)

© 2021-2022 Red Lion Controls, Inc. All rights reserved. Red Lion and the Red Lion logo, are registered trademarks of Red Lion Controls, Inc. All other company and product names are trademarks of their respective owners.

LD1002 01 2022