



# DS 201

## Electronic Pressure Switch

Ceramic Sensor

accuracy according to IEC 60770:  
0.5 % FSO

### Nominal pressure

from 0 ... 400 mbar up to 0 ... 600 bar

### Contacts

1, 2 or 4 independent PNP contacts,  
freely configurable

### Analogue output

2-wire: 4 ... 20 mA

3-wire: 4 ... 20 mA / 0 ... 10 V

others on request

### Special characteristics

- ▶ indication of measured values on a 4-digit LED display
- ▶ rotatable and configurable display module

### Optional versions

- ▶ **IS-version**  
**Ex ia = intrinsically safe for gases**
- ▶ pressure port PVDF
- ▶ customer specific versions



The electronic pressure switch DS 201 is the successful combination of

- ▶ intelligent pressure switch
- ▶ digital display

and has been specially designed for universal usage in industry applications. The DS 201 is available with flush pressure ports for viscous, pasty, and highly polluted media.

As standard the DS 201 offers a PNP contact and a rotatable display module with 4-digit LED display. Optional versions like e.g. an intrinsically safe version, max. four contacts and an analogue output complete the profile.

### Preferred areas of use are

-  Plant and machine engineering
-  Environmental engineering  
(water – sewage – recycling)



Input pressure range <sup>1</sup>																		
Nominal pressure gauge [bar]	-1...0	0.4	0.6	1	1.6	2.5	4	6	10	16	25	40	60	100	160	250	400	600
Nominal pressure abs. [bar]	-	-	0.6	1	1.6	2.5	4	6	10	16	25	40	60	100	160	250	400	600
Level gauge [mH <sub>2</sub> O]	-	4	6	10	16	25	40	60	100	160	250	400	600	-	-	-	-	-
Overpressure [bar]	4	1	2	2	4	4	10	10	20	40	40	100	100	200	400	400	600	800
Burst pressure ≥ [bar]	7	2	4	4	5	5	12	12	25	50	50	120	120	250	500	500	650	880
Vacuum resistance	$p_N \geq 1$ bar: unlimited vacuum resistance $p_N < 1$ bar: on request																	

<sup>1</sup> PVDF pressure port possible for nominal pressure ranges up to 60 bar

Contact <sup>2</sup>	
Standard	1 PNP contact
Options	2 independent PNP contacts 4 independent PNP contacts (possible with M12x1, 8-pin for 4 ... 20 mA/3-wire; 0 ... 10 V/3-wire on request)
Max. switching current	4 ... 20 mA / 2- and 3-wire: contact rating 125 mA, short-circuit resistant; $V_{Switch} = V_S - 2V$ 0 ... 10 V / 3-wire: contact rating 125 mA, short-circuit resistant
Accuracy of contacts <sup>3</sup>	$\leq \pm 0.5$ % FSO
Repeatability	$\leq \pm 0.2$ % FSO
Switching frequency	max. 10 Hz
Switching cycles	$> 100 \times 10^6$
Delay time	0 ... 100 sec

<sup>2</sup> max. 1 contact for 2-wire current signal with plug ISO 4400 as well as 2-wire current signal with IS-protection  
no contact possible with 3-wire in combination with plug ISO 4400

Analogue output (optionally) / Supply	
2-wire current signal	4 ... 20 mA / $V_S = 13 \dots 36 V_{DC}$ permissible load: $R_{max} = [(V_S - V_{Smin}) / 0.02 A] \Omega$ response time: $< 10$ msec
2-wire current signal with IS-protection	4 ... 20 mA / $V_S = 15 \dots 28 V_{DC}$ permissible load: $R_{max} = [(V_S - V_{Smin}) / 0.02 A] \Omega$ response time: $< 10$ msec
3-wire current signal	4 ... 20 mA / $V_S = 19 \dots 30 V_{DC}$ adjustable (turn-down of span 1:5) <sup>4</sup> permissible load: $R_{max} = 500 \Omega$ response time: $< 0.5$ sec
3-wire voltage signal	0 ... 10 V / $V_S = 15 \dots 36 V_{DC}$ permissible load: $R_{min} = 10 k\Omega$ response time: $< 3$ msec
Without analogue output	$V_S = 15 \dots 36 V_{DC}$
Accuracy <sup>3</sup>	$\leq \pm 0.5$ % FSO

<sup>3</sup> accuracy according to IEC 60770 – limit point adjustment (non-linearity, hysteresis, repeatability)

<sup>4</sup> with turn-down of span the analogue signal is adjusted automatically to the new measuring range

Thermal effects (offset and span)	
Thermal error	$\leq \pm 0.2$ % FSO / 10 K
In compensated range	0 ... 85 °C

Permissible temperatures	
Medium <sup>5</sup>	-40 ... 125 °C
Electronics / environment	-40 ... 85 °C
Storage	-40 ... 100 °C

<sup>5</sup> for pressure port in PVDF the medium temperature is -30 ... 60 °C

Electrical protection	
Short-circuit protection	permanent
Reverse polarity protection	no damage, but also no function
Electromagnetic compatibility	emission and immunity according to EN 61326

Mechanical stability	
Vibration	10 g RMS (25 ... 2000 Hz) according to DIN EN 60068-2-6
Shock	500 g / 1 msec according to DIN EN 60068-2-27

Materials			
Pressure port / housing	standard: option for G1/2" open port (up to 60 bar): option for G3/4" flush ( $0.6 \text{ bar} \leq p_N \leq 25 \text{ bar}$ ):	pressure port	housing
		stainless steel 1.4404 PVDF PVDF	stainless steel 1.4404 stainless steel 1.4404 PVDF
Display housing	PA 6.6, polycarbonate		
Seals (media wetted)	standard: FKM option: EPDM ( $p_N \leq 160 \text{ bar}$ ) others on request		
Diaphragm	ceramics Al <sub>2</sub> O <sub>3</sub> 96 %		
Media wetted parts	pressure port, seals, diaphragm		

<b>Explosion protection (only for 4 ... 20 mA / 2-wire)</b>	
Approval AX14-DS 201	IBExU 06 ATEX 1050 X zone 1: II 2G Ex ia IIC T4 Gb (connector) / II 2G Ex ia IIB T4 Gb (cable)
Safety tech. maximum values	$U_i = 28 \text{ V}$ , $I_i = 93 \text{ mA}$ , $P_i = 660 \text{ mW}$ , $C \approx 0 \text{ nF}$ , $L_i \approx 0 \text{ }\mu\text{H}$
Max. switching current <sup>6</sup>	70 mA
Permissible temperatures for environment	-25 ... 70 °C
Connecting cables (by factory)	cable capacitance: signal line/shield also signal line/signal line: 100 pF/m cable inductance: signal line/shield also signal line/signal line: 1 $\mu\text{H}/\text{m}$

<sup>6</sup> the real switching current in the application depends on the power supply unit

<b>Miscellaneous</b>	
Display	4-digit, red 7-segment-LED display digit height 7 mm range of indication -1999 ... +9999 accuracy 0.1 % $\pm$ 1 digit digital damping 0.3 ... 30 sec (programmable); measured value update 0.0 ... 10 sec (programmable)
Option oxygen application <sup>7</sup>	for $p_N \leq 25 \text{ bar}$ : O-ring in FKM Vi 567 (with BAM-approval); permissible maximum values are 25 bar / 150° C
Current consumption (without contacts)	2-wire signal output current: max. 25 mA 3-wire signal output current: approx. 45 mA + signal current 3-wire signal output voltage: approx. 45 mA
Ingress protection	IP 65
Installation position	any
Weight	approx. 200 g
Operational life	100 million load cycles
CE-conformity	EMC Directive: 2014/30/EU Pressure Equipment Directive: 2014/68/EU (module A) <sup>8</sup>
ATEX Directive	2014/34/EU

<sup>7</sup> not possible with flush pressure ports

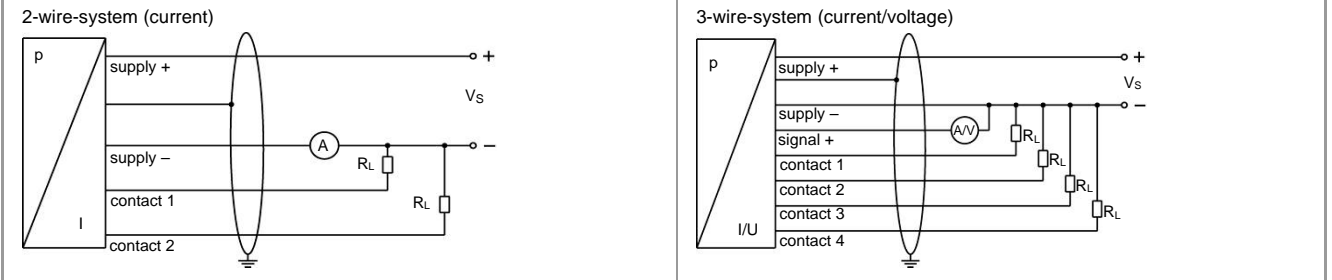

<sup>8</sup> this directive is only valid for devices with maximum permissible overpressure > 200 bar

**Wiring diagrams**

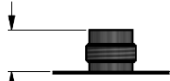
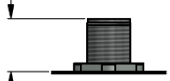
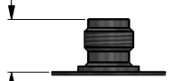

**Pin configuration**

Electrical connection	M12x1 plastic (5-pin)	M12x1 metal (5-pin)	M12x1 plastic (8-pin)	ISO 4400	Binder series 723 (5-pin)	cable colours (IEC 60757)
Supply +	1	1	1	1	1	WH (white)
Supply -	3	3	3	2	3	BN (brown)
Signal + (only 3-wire)	2	2	2	3	2	GN (green)
Contact 1	4	4	4	3	4	GY (grey)
Contact 2	5	5	5	-	5	PK (pink)
Contact 3	-	-	6	-	-	-
Contact 4	-	-	7	-	-	-
Shield	via pressure port	plug housing/pressure port	via pressure port	ground contact $\oplus$	plug housing/pressure port	GNYE (green-yellow)

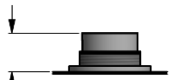
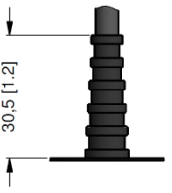
Electrical connections (dimensions mm / in)		
 <p>10 [0.39]</p> <p>M12x1 plastic (5-pin)</p>	 <p>13 [0.51]</p> <p>M12x1 metal (5-pin)</p>	 <p>13 [0.51]</p> <p>M12x1 plastic (8-pin)</p>
 <p>12 [0.47]</p> <p>ISO 4400</p>	 <p>10 [0.37]</p> <p>Binder series 723 (5-pin)</p>	 <p>30.5 [1.2]</p> <p>cable outlet<sup>9</sup></p>

<sup>9</sup> different cable types and lengths available; permissible temperature depends on kind of cable; standard: 2 m PVC cable (without ventilation tube, permissible temperature: -5 ... 70 °C)

**Dimensions (mm / in)**

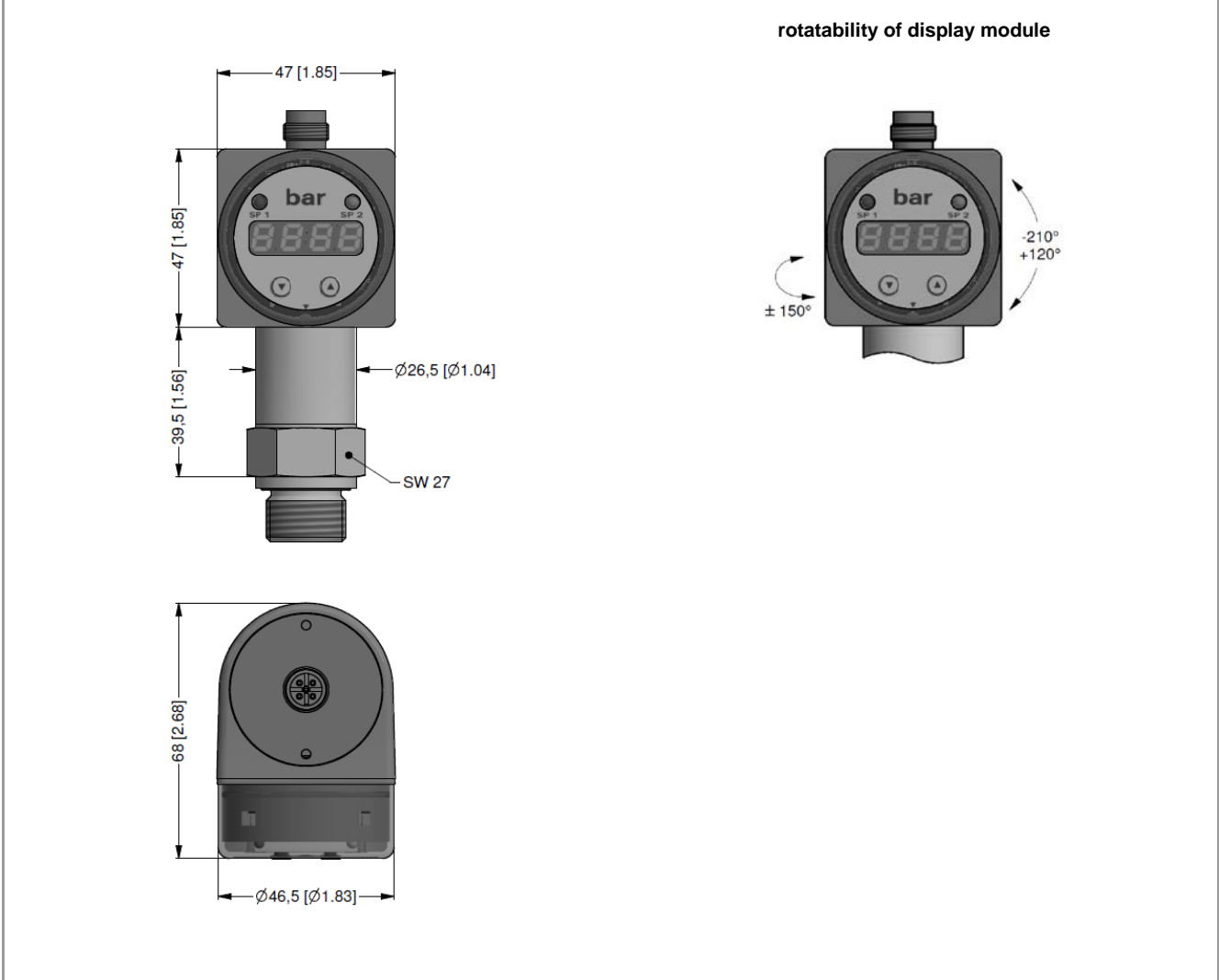

**Mechanical connection (dimensions mm / in)**

**G1/2" DIN 3852**  
 17 [0.67]  
 14 [0.55]  
 G1/2"

**G1/2" EN 837**  
 SW27  
 23 [0.91]  
 3 [0.12]  
 G1/2"

**1/2" NPT**  
 SW27  
 20 [0.79]  
 1/2" NPT

**G1/4" DIN 3852**  
 SW27  
 14 [0.55]  
 12 [0.47]  
 G1/4"

**G1/4" EN 837**  
 SW27  
 15 [0.59]  
 2 [0.08]  
 G1/4"

**1/4" NPT**  
 SW27  
 14 [0.55]  
 1/4" NPT

**G1/2" open port DIN 3852**  
 SW27  
 17 [0.67]  
 14 [0.55]  
 G1/2"  
 Ø10 [Ø0.39]

**G1/2" semi-flush DIN 3852 (0.6 bar ≤ p<sub>N</sub> ≤ 60 bar gauge)**  
 SW27  
 X  
 17 [0.67]  
 14 [0.55]  
 G1/2"  
 X (2:1)  
 1,9 [0.07]  
 Ø10 [Ø0.39]

**G3/4" semi-flush DIN 3852 (0.6 bar ≤ p<sub>N</sub> ≤ 60 bar gauge)**  
 SW27  
 19 [0.75]  
 16 [0.63]  
 G3/4"  
 Ø40 [Ø1.57]

length of device: 97.5 mm (without plug)

length of device: 87.5 mm (without plug)

↔ metric threads and other versions on request

© 2023 BDSENSORS GmbH – The specifications given in this document represent the state of engineering at the time of publishing. We reserve the right to make modifications to the specifications and materials.

